

SAVANNAH 400

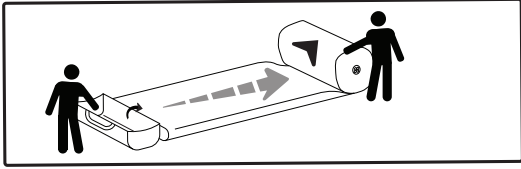

A.

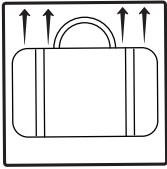
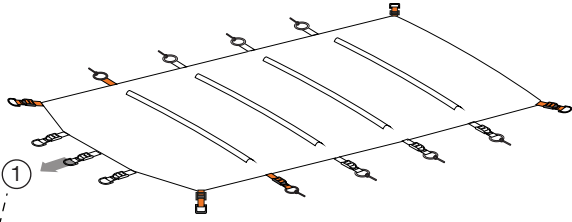

B.

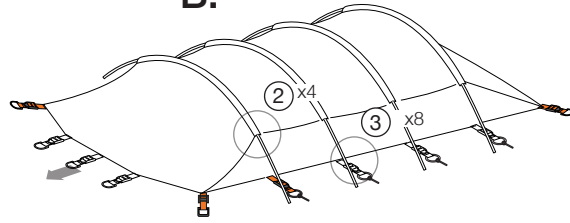

C.

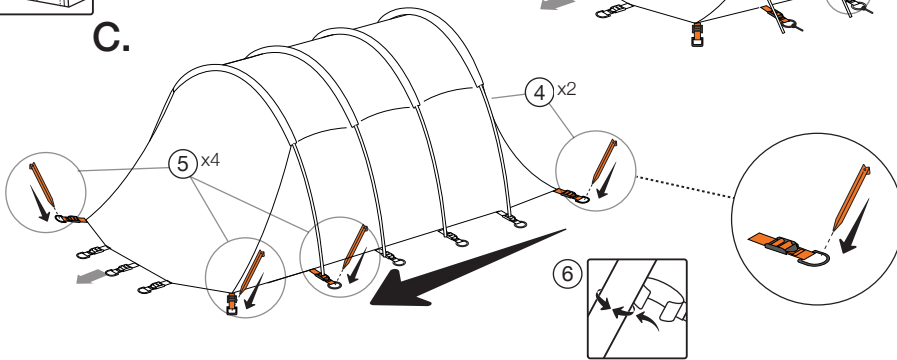

D.

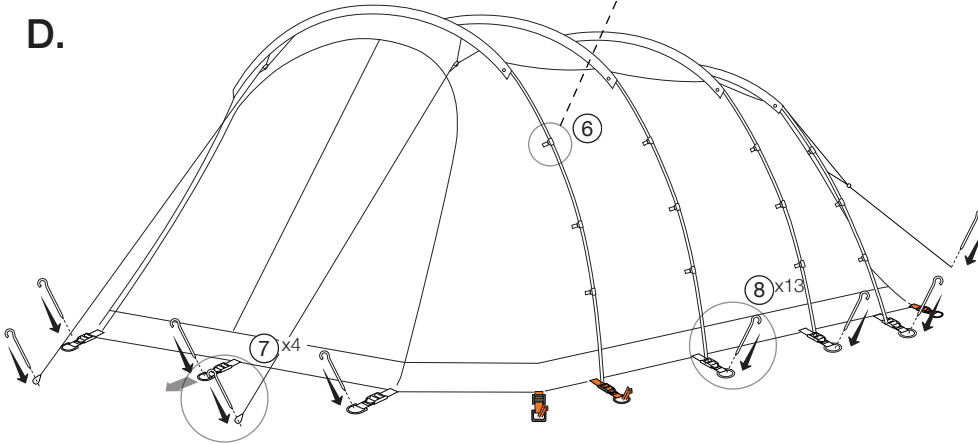

E.

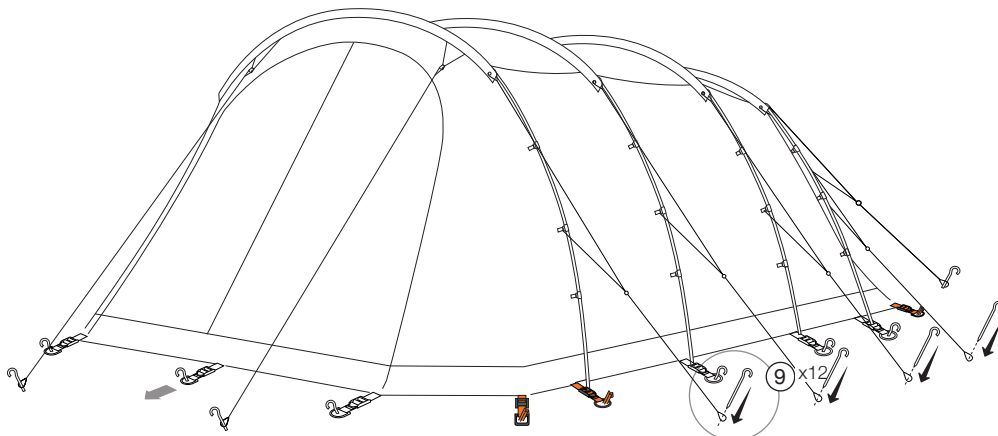

Poles

2

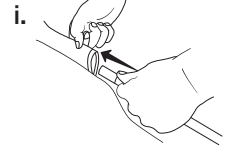

3

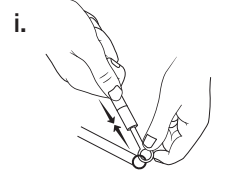

TBS® II

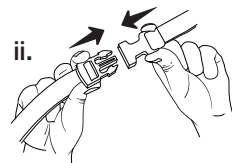

SAVANNAH 400

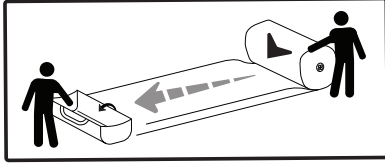
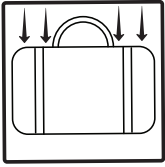

A.

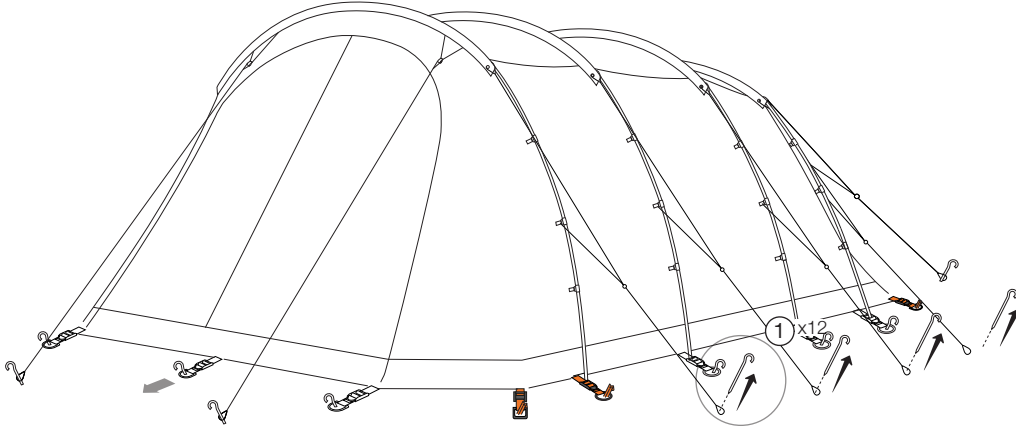

B.

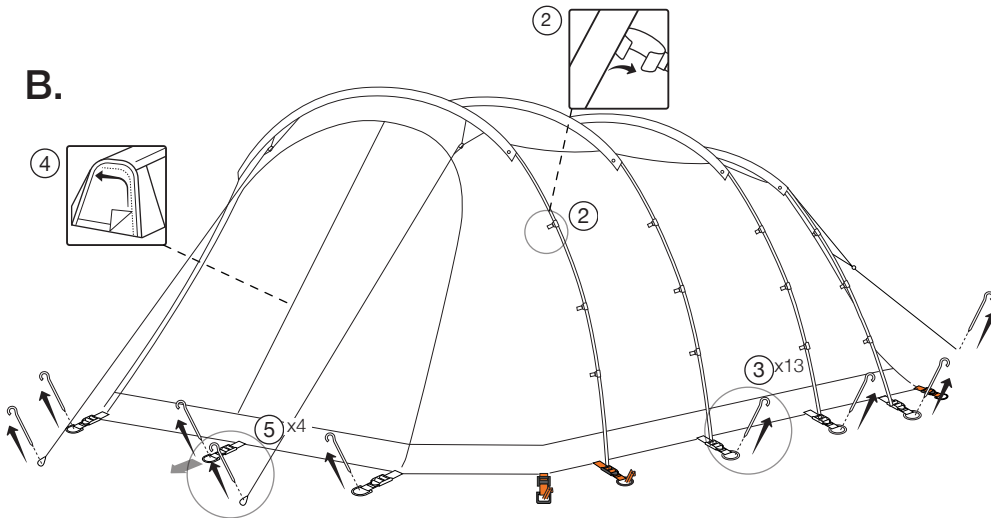

Poles

7

i.

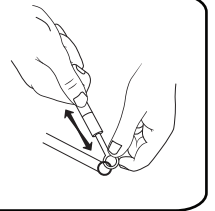

8

i.

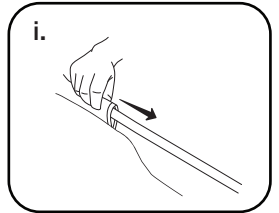

9

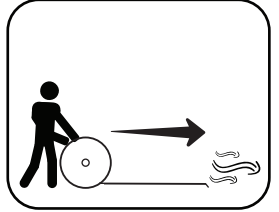

C.

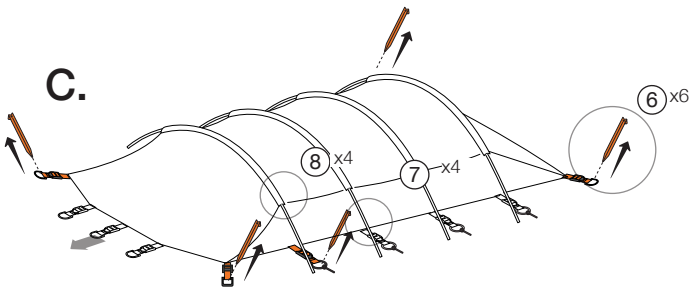

D.

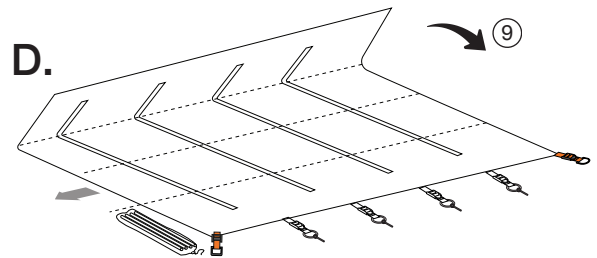

E.

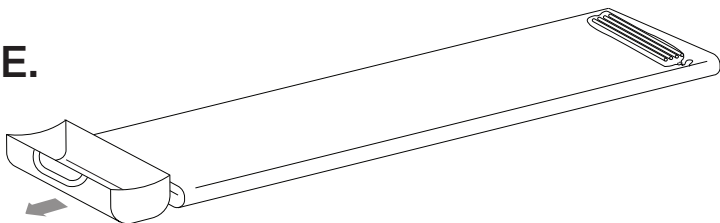

F.

