

# ANANTARA IV AIR 450XL



**EN** - This tent should be erected by at least 2 people

**CZ** - Tento stan by měl být postaven nejméně 2 osobami

**DE** - Dieses Zelt sollte von mindestens zwei Personen aufgestellt werden

**FR** - Cette tente doit être érigée par au moins 2 personnes

**IT** - Questa tenda deve essere eretta da almeno 2 persone

**NL** - Deze tent moet worden omgeven door minstens 2 personen

## PITCHING

**A.**

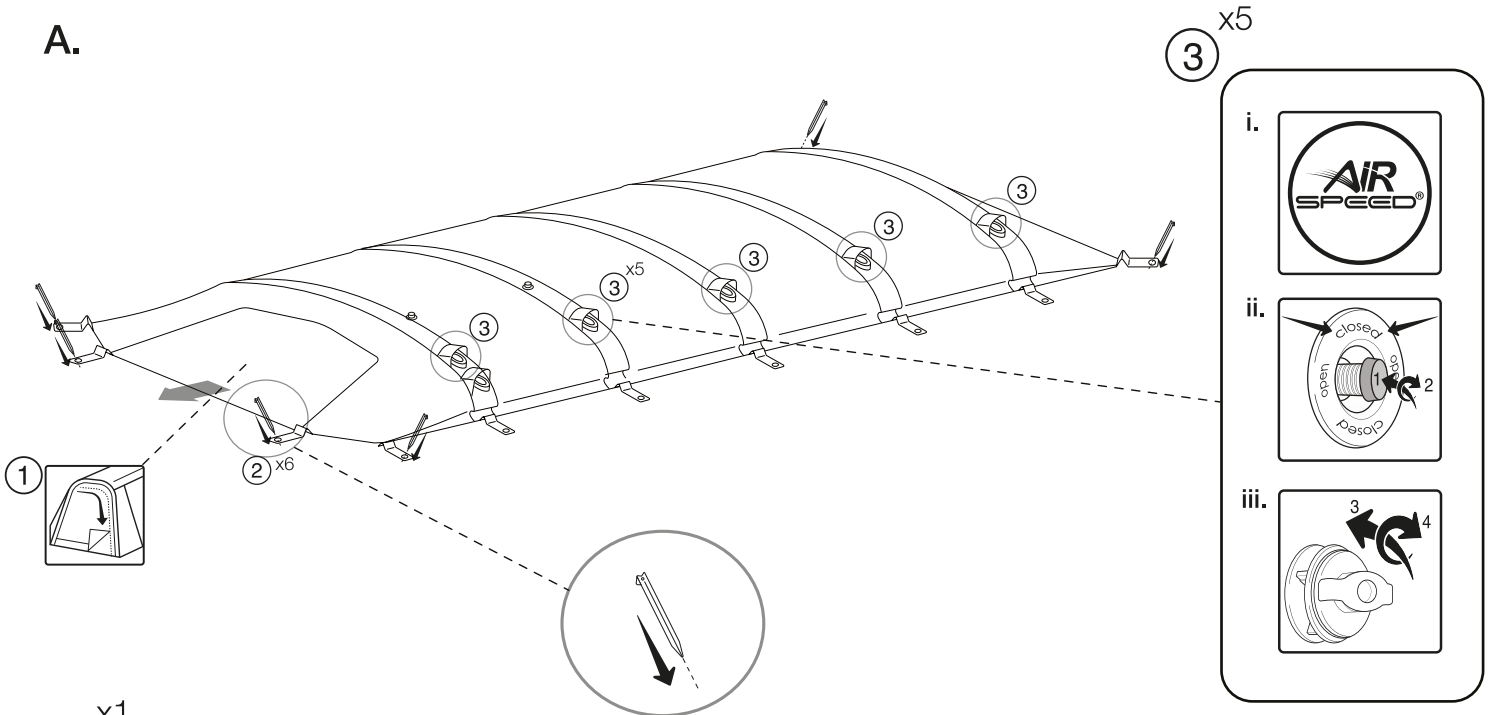

**4** x1

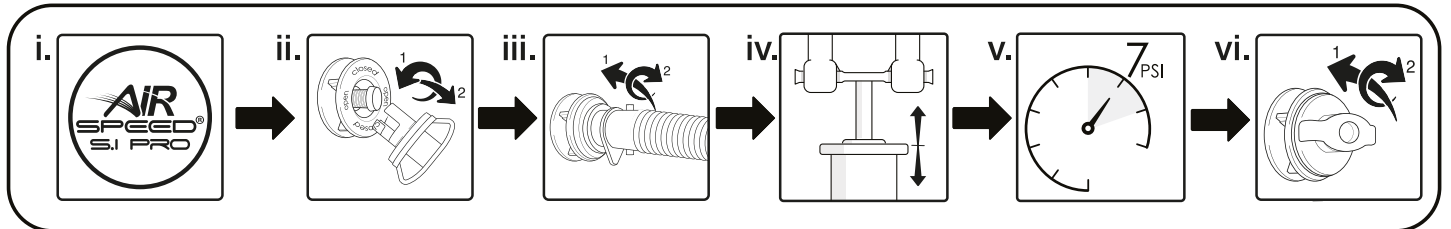

**B.**

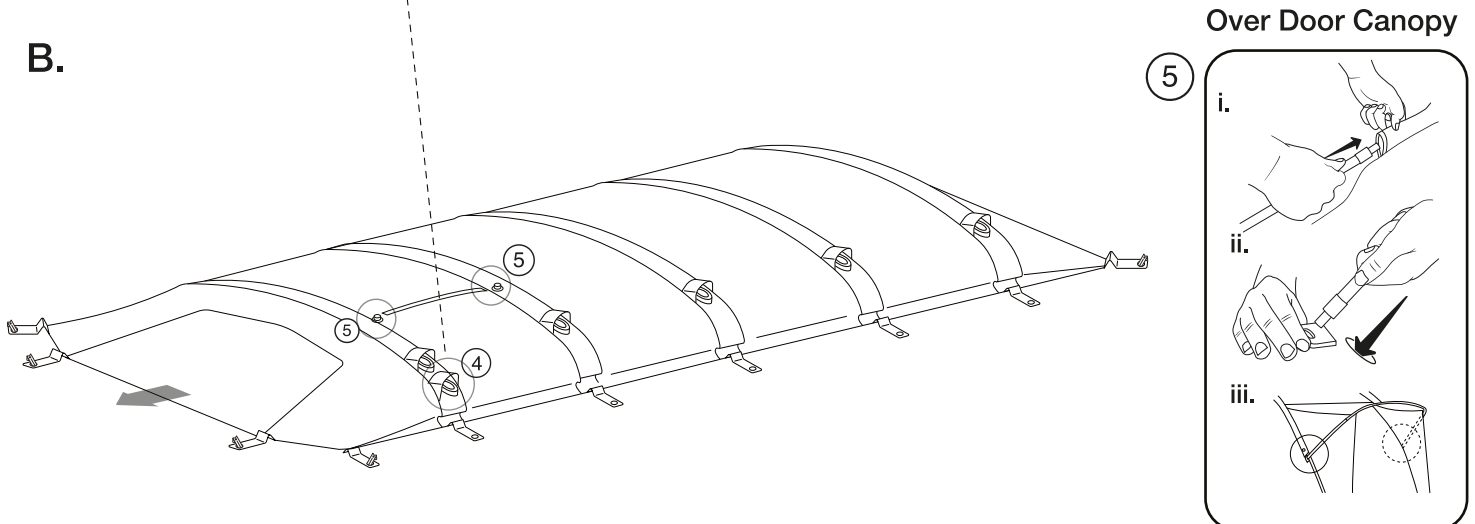

**Over Door Canopy**

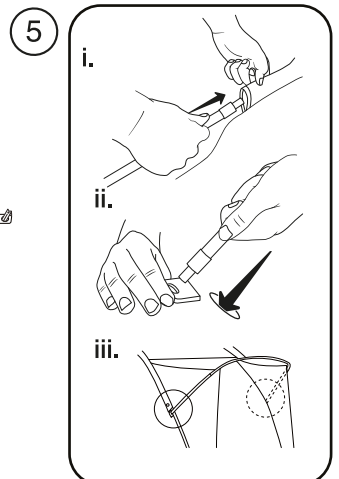

# ANANTARA IV AIR 450XL



**EN** - This tent should be erected by at least 2 people

**CZ** - Tento stan by měl být postaven nejméně 2 osobou

**DE** - Dieses Zelt sollte von mindestens zwei Personen aufgestellt werden

**FR** - Cette tente doit être érigée par au moins 2 personnes

**IT** - Questa tenda deve essere eretta da almeno 2 persone

**NL** - Deze tent moet worden omgeven door minstens 2 personen

## PITCHING

C.

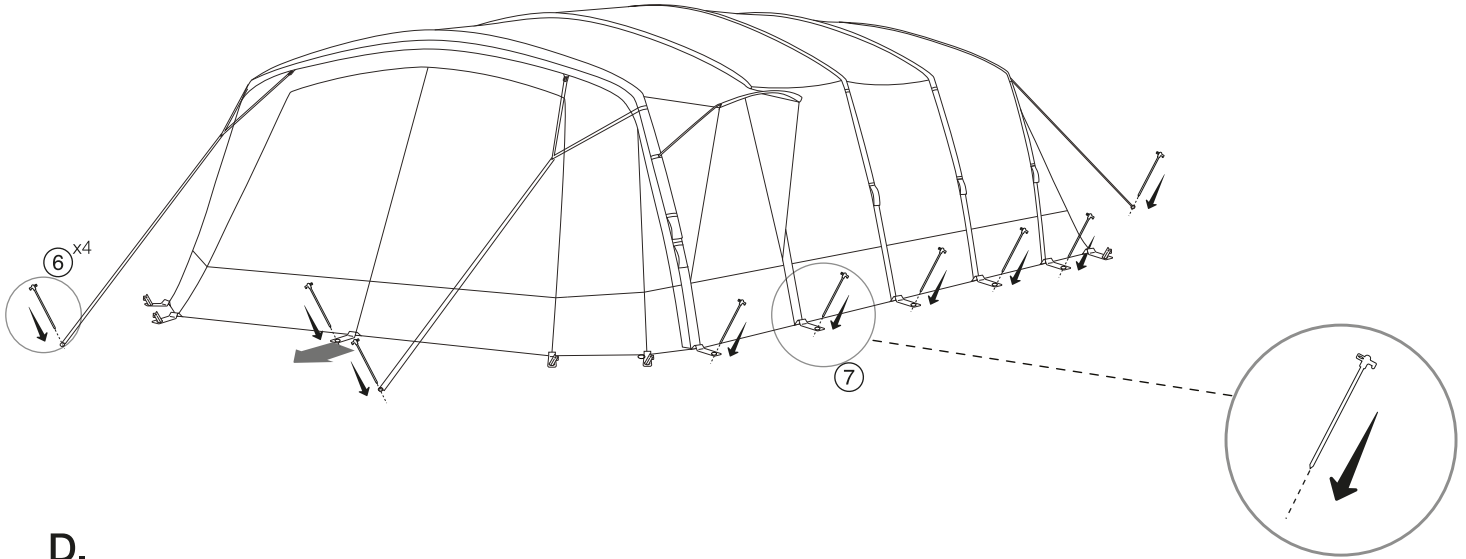

D.

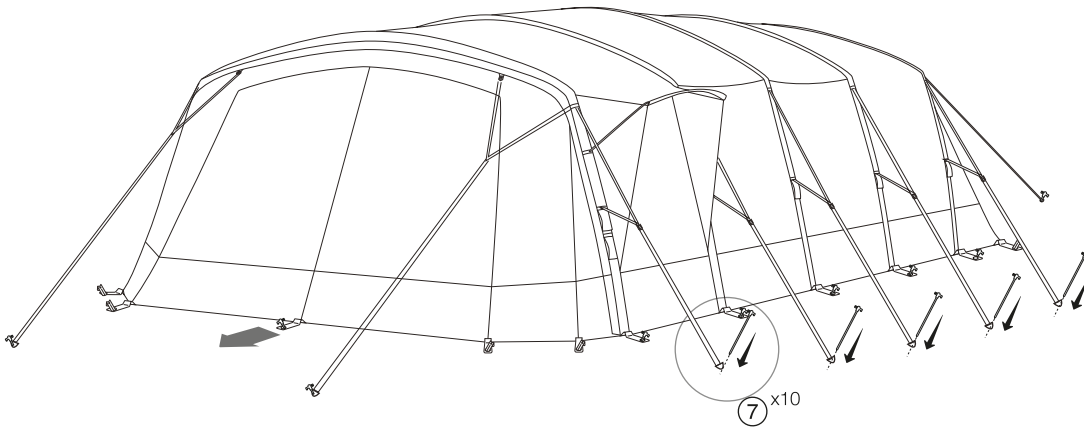

TBS®II

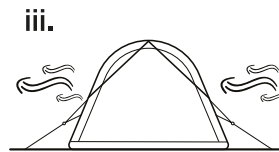
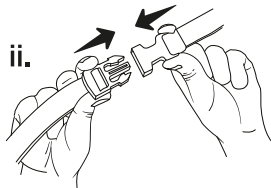
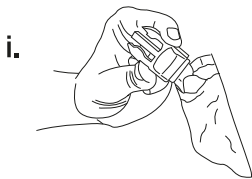
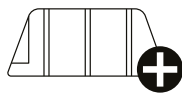

# ANANTARA IV AIR 450XL



**EN** - This tent should be erected by at least 2 people

**CZ** - Tento stan by měl být postaven nejméně 2 osobou

**DE** - Dieses Zelt sollte von mindestens zwei Personen aufgestellt werden

**FR** - Cette tente doit être érigée par au moins 2 personnes

**IT** - Questa tenda deve essere eretta da almeno 2 persone

**NL** - Deze tent moet worden omgeven door minstens 2 personen

## TAKING DOWN & PACKING

**A.**

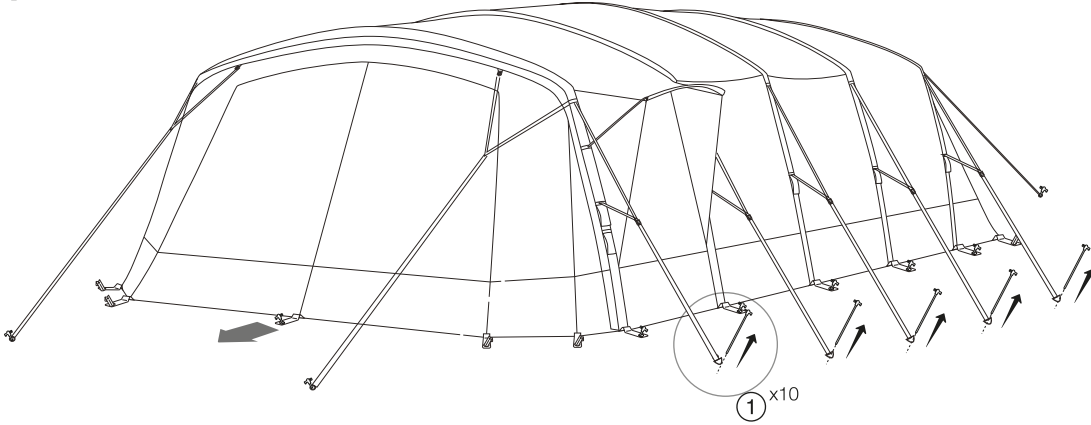

**B.**

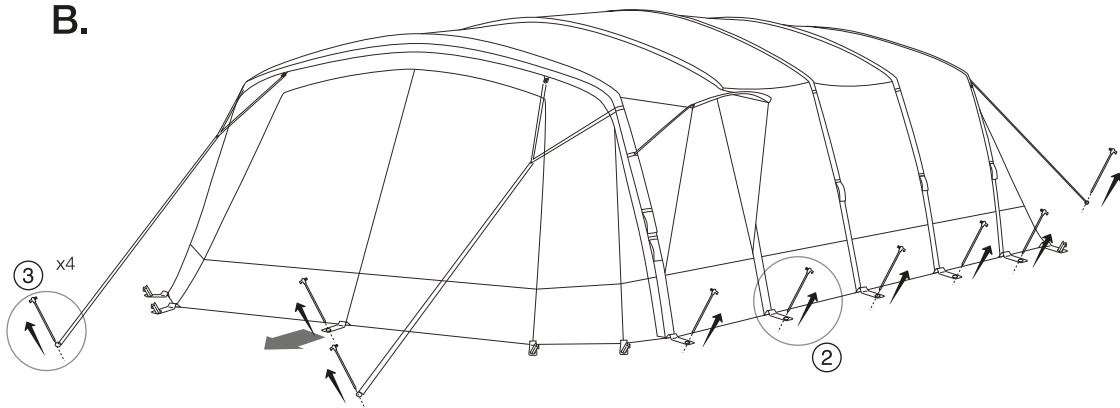

**C.**

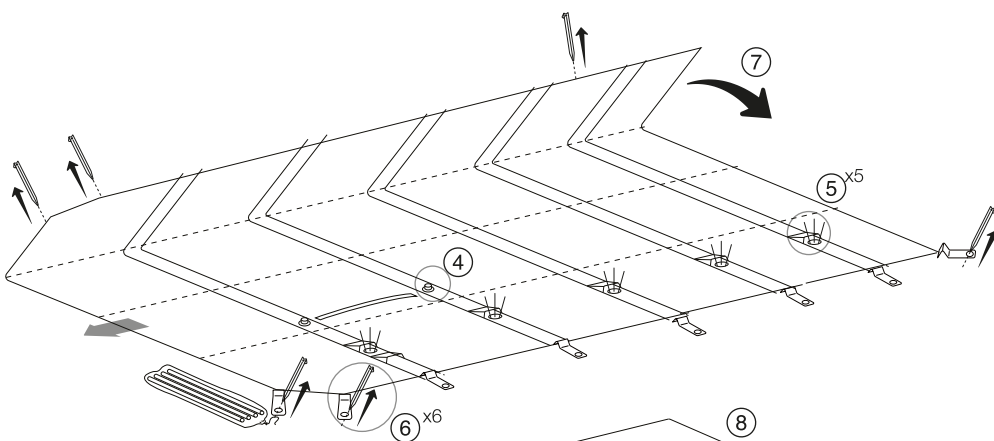

**D.**

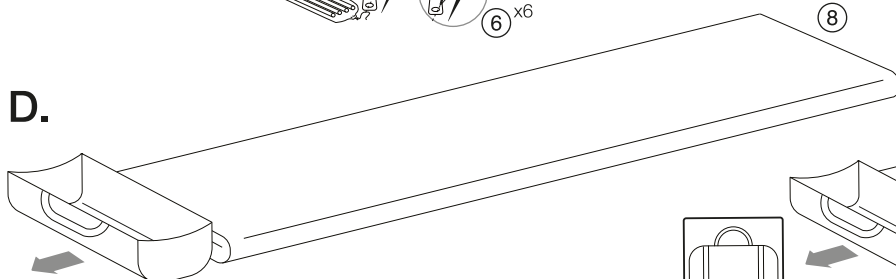

**E.**

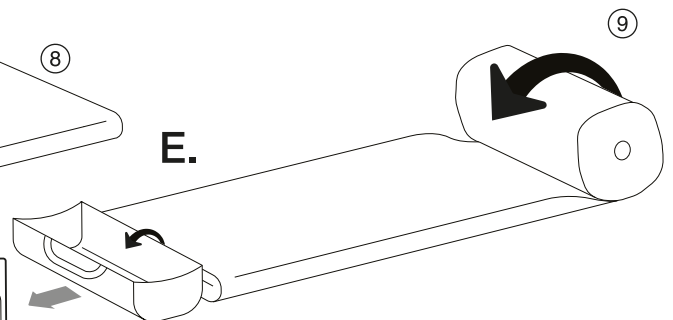

### Over Door Canopy

④

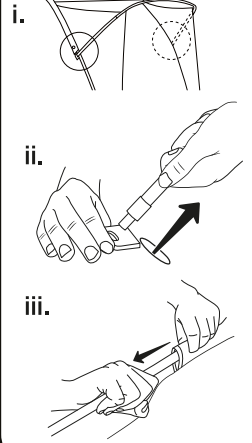

### Airspeed®

⑤

